

A red JAKA collaborative robot arm is the central focus, extending from the top right towards the center. The arm is cylindrical with silver-colored joints and a silver cap at the end. The word "JAKA" is printed in red on one of the joints. The background is a blurred industrial factory floor with various equipment and structures. A red rectangular overlay is positioned on the left side of the image, containing the company name and tagline.

# JAKA

High-Performance Collaborative  
Robots for Affordable Automation



# JAKA

## Product Matrix



  
Ease of Use

  
Safety

  
Reliability

  
Compatibility

## Flexible • Intelligent

Adapting to various application scenarios  
to meet the needs of all industries.



JAKA S series



JAKA Pro series



JAKA Zu series



JAKA Mini series



JAKA Lens 2D



JAKA Vision Protection System



## No Teach Pendant

Operating JAKA collaborative robots does not require a traditional teach pendant. It can be easily carried out via a tablet, smartphone, or PC, offering great flexibility.

---



## Wireless Connection

With wireless connectivity, communicating with and assigning tasks to a cobot is effortless. No more wires! Enjoy a cleaner, safer workspace with JAKA cobots.

---



## Safe Human-Robot Collaboration

JAKA cobots are designed for safe interactions with humans – no safety fence required – thanks to collision detection, enabled by a built-in torque feedback module. Users can adjust flexibility, so that even the lightest bump will cause the cobot to stop, preventing harm.

---



## Graphic Programming

Program effortlessly on any graphical device – PC, tablet, or phone. The intuitive software requires no prior programming experience, allowing anyone to easily set and adjust positions and tasks.

---



## Drag Teaching

Users and integrators can deploy a cobot in minutes using drag teaching. Simply move the cobot to any position, and it will instantly memorize it.

---





## Plug-and-Play

A few minutes is all it takes to install JAKA cobots. Whether on a horizontal or a vertical surface, they are easy to mount and ready to go. Flexible and lightweight, the cobots are compatible with a wide range of grippers and end effectors. This plug-and-play design allows users to quickly deploy and re-deploy in any production environment.

---

**JAKA Zu Cobots**

- 

**Simplified**  
Plug and play setup, convenient deployment, flexible production.
- 

**Intelligent**  
Flexible, intelligent, easy to operate, and efficient in collaboration.
- 

**Specialized**  
Built for reliable performance in various high-precision collaborative tasks.

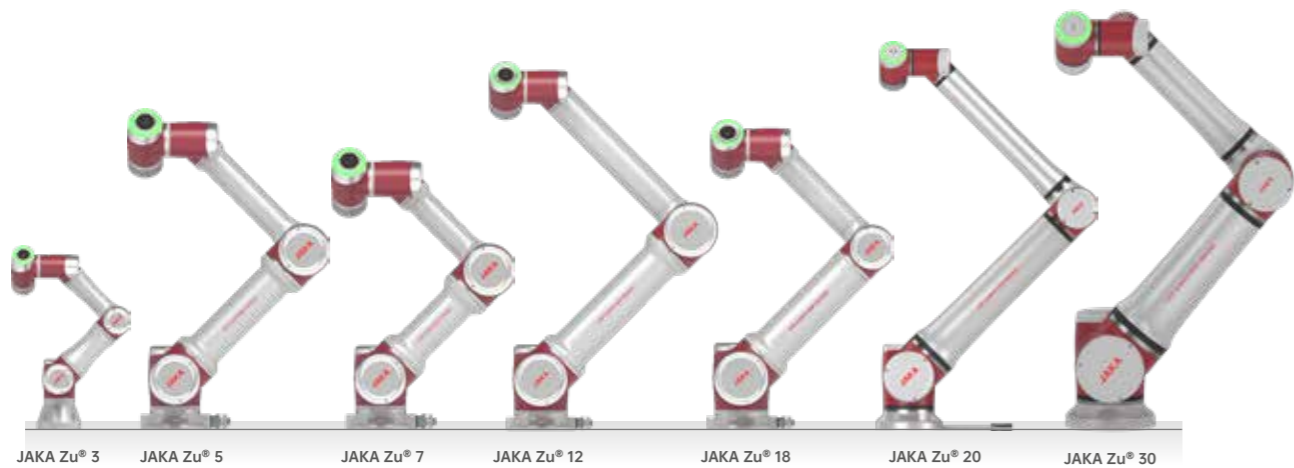

**JAKA S Cobots**

- 

**Highly Sensitive**  
Optimized drag teaching for superior precision and control.
- 

**User-Friendly**  
Simple app setup with real-time force value display.
- 

**Practical**  
Multiple force control modes with consistent force accuracy.
- 

**Safe**  
Full-arm collision detection self-learning monitoring.

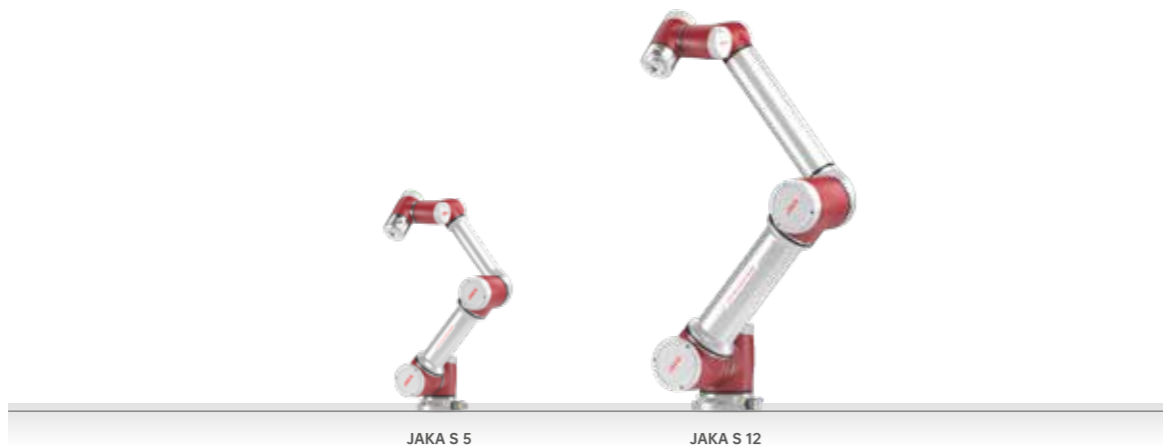

**JAKA Pro Cobots**

- 

**Exceptional Durability**  
Industry's highest IP68 protection level - fully resistant to oil and dust.
- 

**Reduced Maintenance**  
High-precision, low-maintenance design for worry-free production.
- 

**Enhanced Efficiency**  
Fast, intelligent operation with seamless and safe integration.

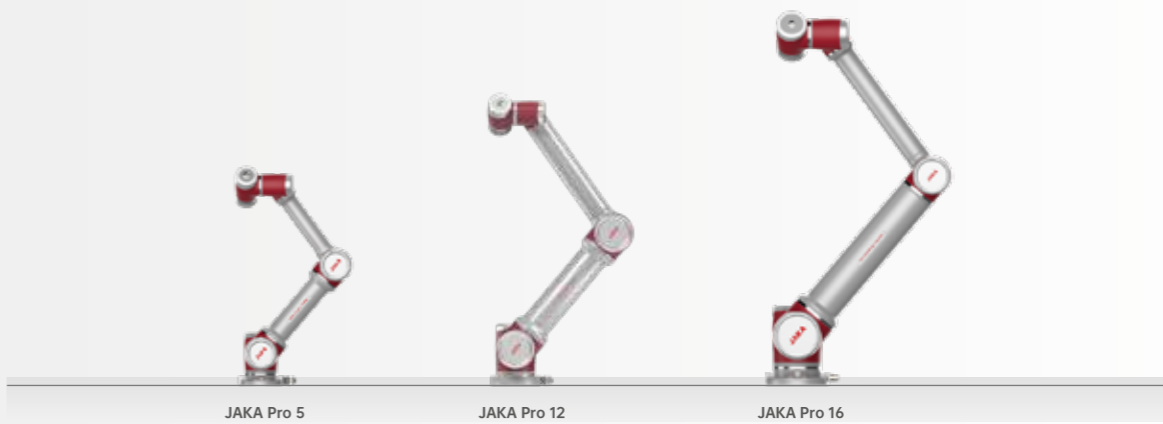

**JAKA MiniCobo**

- 

**Business-Ready**  
Compact, low-noise design. Ideal for hospitality, education, retail, and services.
- 

**Lightweight**  
Weighing under 10 kg, it offers exceptional portability and convenience.
- 

**Cost-Effective**  
Achieve high-quality results with a low initial investment.



# JAKA Zu

**Ease of Integration**

Plug-and-play, easy deployment, with a compact footprint.

**Ease of Use**

Built-in torque feedback, drag teaching, and graphic programming for easy use.

**High Precision**

Excellent repeatability, accuracy, and an MTBF of 80,000 hours.

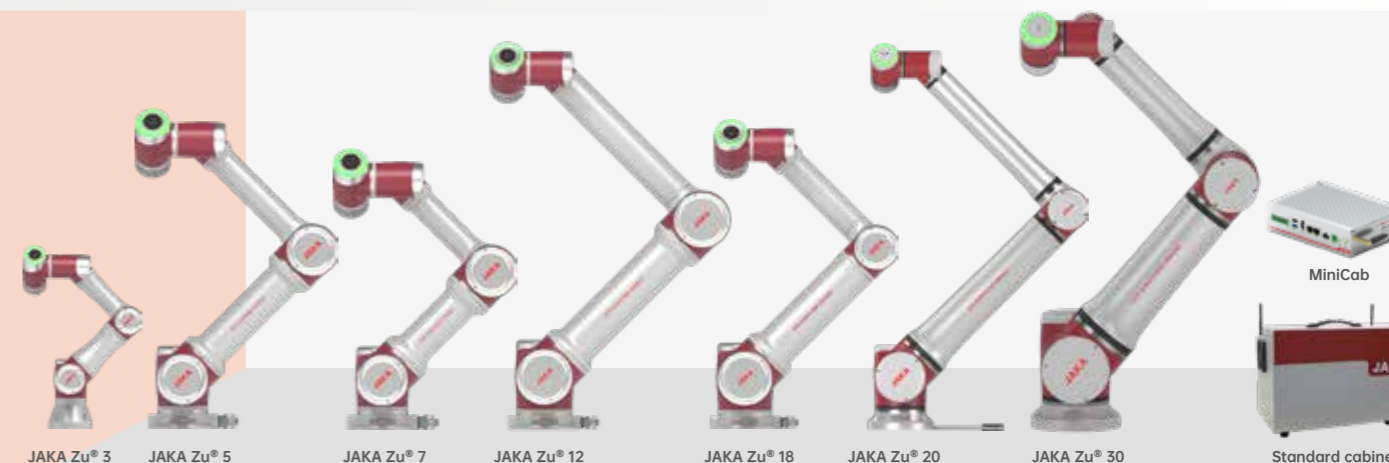

Product features	JAKA Zu® 3		JAKA Zu® 5		JAKA Zu® 7		JAKA Zu® 12		JAKA Zu® 18		JAKA Zu® 20		JAKA Zu® 30		
	Maximum payload	3 kg		5 kg		7 kg		12 kg		18 kg		20 kg		30 kg	
Weight	12 kg		23 kg		22 kg		41 kg		35 kg		68 kg		65 kg		
Reach	626 mm		954 mm		819 mm		1327 mm		1073 mm		1780 mm		1350 mm		
Accuracy	±0.02 mm		±0.02 mm		±0.02 mm		±0.03 mm		±0.03 mm		±0.05 mm		±0.05 mm		
Number of axis	6		6		6		6		6		6		6		
Programming	Drag teaching and graphic programming		Drag teaching and graphic programming		Drag teaching and graphic programming		Drag teaching and graphic programming		Drag teaching and graphic programming		Drag teaching and graphic programming		Drag teaching and graphic programming		
Teach pendant	PC, mobile (PAD/mobile)		PC, mobile (PAD/mobile)		PC, mobile (PAD/mobile)		PC, mobile (PAD/mobile)		PC, mobile (PAD/mobile)		PC, mobile (PAD/mobile)		PC, mobile (PAD/mobile)		
Movement	Robot joint	Working range	Maximum speed	Working range	Maximum speed	Working range	Maximum speed	Working range	Maximum speed	Working range	Maximum speed	Working range	Maximum speed	Working range	Maximum speed
	Joint 1	±360°	180°/s	±360°	180°/s	±360°	180°/s	±360°	120°/s	±360°	120°/s	±360°	120°/s	±360°	120°/s
	Joint 2	-85°, +265°	180°/s	-85°, +265°	180°/s	-85°, +265°	180°/s	-85°, +265°	120°/s	-85°, +265°	120°/s	-85°, +265°	120°/s	-85°, +265°	120°/s
	Joint 3	±175°	180°/s	±175°	180°/s	±175°	180°/s	±175°	120°/s	±175°	180°/s	±175°	120°/s	±175°	120°/s
	Joint 4	-85°, +265°	220°/s	-85°, +265°	180°/s	-85°, +265°	180°/s	-85°, +265°	180°/s	-85°, +265°	180°/s	-85°, +265°	220°/s	-85°, +265°	220°/s
	Joint 5	±360°	220°/s	±360°	180°/s	±360°	180°/s	±360°	180°/s	±360°	180°/s	±360°	220°/s	±360°	220°/s
	Joint 6	±360°	220°/s	±360°	180°/s	±360°	180°/s	±360°	180°/s	±360°	180°/s	±360°	220°/s	±360°	220°/s
	Maximum linear speed	/	1.5 m/s	/	3 m/s	/	2.5 m/s	/	3 m/s	/	3.5 m/s	/	1.5 m/s	/	4.2 m/s
Specifications	Nominal power consumption	150 W		350 W		350 W		500 W		600 W		750 W		750 W	
	IP classification	IP54		IP54		IP54		IP54		IP54		IP65		IP65	
	Tool I/O ports	Digital input 2		Digital input 2		Digital input 2		Digital input 2		Digital input 2		Digital input 2		Digital input 2	
		Digital output 2		Digital output 2		Digital output 2		Digital output 2		Digital output 2		Digital output 2		Digital output 2	
		Analog input 1		Analog input 1		Analog input 1		Analog input 1		Analog input 1		Analog input 1		Analog input 1	
Base diameter	129 mm		158 mm		158 mm		188 mm		188 mm		246 mm		246 mm		
Electrical cabinet	IP classification	IP44		IP44		IP44		IP44		IP44		IP44		IP44	
	I/O ports	16 digital inputs, 16 digital outputs, 2 analog inputs or outputs		16 digital inputs, 16 digital outputs, 2 analog inputs or outputs		16 digital inputs, 16 digital outputs, 2 analog inputs or outputs		16 digital inputs, 16 digital outputs, 2 analog inputs or outputs		16 digital inputs, 16 digital outputs, 2 analog inputs or outputs		16 digital inputs, 16 digital outputs, 2 analog inputs or outputs		16 digital inputs, 16 digital outputs, 2 analog inputs or outputs	
	Communication	TCP/IP, Modbus TCP, Modbus RTU, Profinet, Ethernet/IP		TCP/IP, Modbus TCP, Modbus RTU, Profinet, Ethernet/IP		TCP/IP, Modbus TCP, Modbus RTU, Profinet, Ethernet/IP		TCP/IP, Modbus TCP, Modbus RTU, Profinet, Ethernet/IP		TCP/IP, Modbus TCP, Modbus RTU, Profinet, Ethernet/IP		TCP/IP, Modbus TCP, Modbus RTU, Profinet, Ethernet/IP		TCP/IP, Modbus TCP, Modbus RTU, Profinet, Ethernet/IP	
	Power	100-240 VAC, 50-60 Hz		100-240 VAC, 50-60 Hz		100-240 VAC, 50-60 Hz		100-240 VAC, 50-60 Hz		100-240 VAC, 50-60 Hz		100-240 VAC, 50-60 Hz		100-240 VAC, 50-60 Hz	
	Size	410×307×235 mm (W×H×D)		410×307×235 mm (W×H×D)		410×307×235 mm (W×H×D)		410×307×235 mm (W×H×D)		410×307×235 mm (W×H×D)		410×307×235 mm (W×H×D)		410×307×235 mm (W×H×D)	
	Weight	13.5 kg		15.4 kg		15.4 kg		18 kg		18 kg		18 kg		18 kg	

# JAKA S

**Improved Durability**  
IP65 rating for superior protection.

**Precision Handling**  
Integrated force control for effortless operation.

**Easy Deployment**  
Instant access to force control at a glance.



Product features	Product parameters		JAKA S 5		JAKA S 12	
		Maximum payload		5 kg		12 kg
	Reach		954 mm		1327 mm	
	Number of axis		6		6	
	Nominal power consumption		350 w		500 w	
	Operational temperature		-10~50°C			
Force/torque sensor performance	Force/torque sensor	Force, x-y-z	Torque, x-y-z	Force, x-y-z	Torque, x-y-z	
	Measurement range	200 N	24 Nm	400 N	48 Nm	
	Max force/torque limit	3000 N	300 Nm	3000 N	300 Nm	
	Accuracy of maximum range	1% F.S.	1% F.S.	1% F.S.	1% F.S.	
	Force/torque resolution	0.1 N	0.1 Nm	0.1 N	0.1 Nm	
Movement	Typical TCP speed	1 m/s	/	1 m/s	/	
	Accuracy	±0.02 mm	/	±0.03 mm	/	
	<b>Robot joint</b>	<b>Working range</b>	<b>Maximum speed</b>	<b>Working range</b>	<b>Maximum speed</b>	
	Joint 1	±360°	180°/s	±360°	120°/s	
	Joint 2	-85°~+265°	180°/s	-85°~+265°	120°/s	
	Joint 3	±175°	180°/s	±175°	120°/s	
	Joint 4	-85°~+265°	180°/s	-85°~+265°	180°/s	
Joint 5	±360°	180°/s	±360°	180°/s		
Joint 6	±360°	180°/s	±360°	180°/s		
Specifications	IP classification	IP 65		IP 65		
	Robot mounting angle	Any orientation		Any orientation		
	Base diameter	158 mm		188 mm		
	Materials	Aluminium, PC		Aluminium, PC		
	Robot connection cable length	6 m		6 m		
	Weight	23 kg		41 kg		
Humidity	10~90% RH					

## JAKA S 5 Drawings

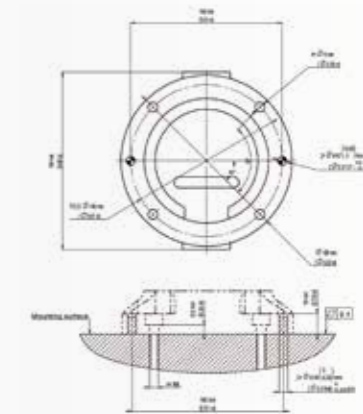
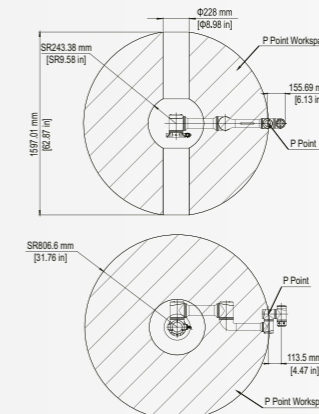
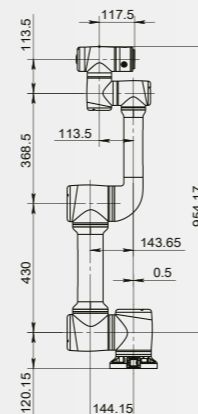

## JAKA S 12 Drawings

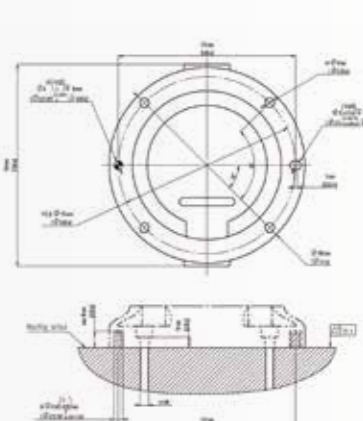
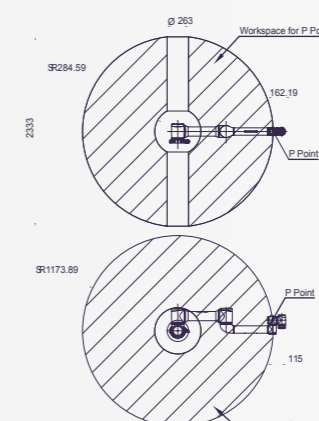
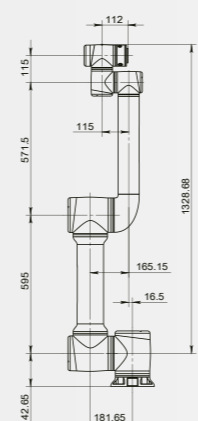

# JAKA Pro

**Robust Durability**

IP68 protection for maximum durability — dust, oil, and water-resistant.

**Steady Performance**

±0.02 mm accuracy for reliable, 24/7 unsupervised operation.

**Quick Deployment**

Fast to deploy, easy to integrate and straightforward to reprogram.

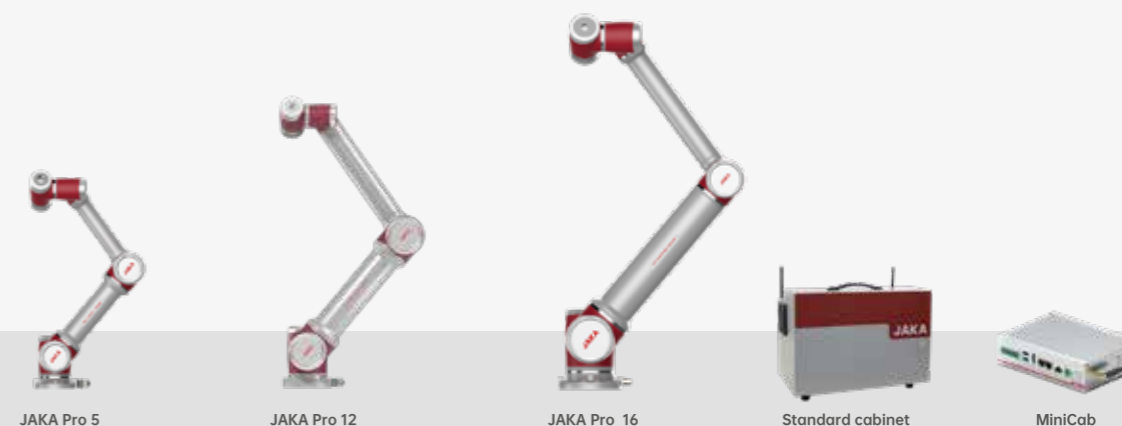

Product features	Product parameters		JAKA Pro 5		JAKA Pro 12		JAKA Pro 16		
	Maximum payload		5 kg		12 kg		16 kg		
Weight		23.5 kg		41 kg		74 kg			
Reach		954 mm		1327 mm		1713 mm			
Accuracy		±0.02 mm		±0.02 mm		±0.02 mm			
Number of axis		6		6		6			
Programming		Drag teaching and graphic programming		Drag teaching and graphic programming		Drag teaching and graphic programming			
Teach pendant		PC, mobile (PAD/mobile)		PC, mobile (PAD/mobile)		PC, mobile (PAD/mobile)			
Movement	Robot joint	Working range	Maximum speed		Working range	Maximum speed		Working range	Maximum speed
	Joint 1	±360°	180°/s		±360°	120°/s		±360°	120°/s
	Joint 2	-85°, +265°	180°/s		-85°, +265°	120°/s		-85°, +265°	180°/s
	Joint 3	±175°	180°/s		±175°	180°/s		±175°	180°/s
	Joint 4	-85°, +265°	180°/s		-85°, +265°	180°/s		-85°, +265°	180°/s
	Joint 5	±360°	180°/s		±360°	180°/s		±360°	180°/s
	Joint 6	±360°	180°/s		±360°	180°/s		±360°	180°/s
Maximum linear speed	/	3 m/s		/	3 m/s		/	3.9 m/s	
Specifications	Nominal power consumption	350 W		500 W		350 W			
	IP classification	IP68		IP68		IP68			
	Tool end I/O interface	Digital input 2		Digital input 2		Digital input 2			
		Digital output 2		Digital output 2		Digital output 2			
		Analog input 1		Analog input 1		Analog input 1			
Base diameter	158 mm		188 mm		246 mm				
Electrical cabinet	IP classification	IP44		IP44		IP44			
	I/O ports	16 digital inputs, 16 digital outputs, 2 analog inputs or outputs		16 digital inputs, 16 digital outputs, 2 analog inputs or outputs		16 digital inputs, 16 digital outputs, 2 analog inputs or outputs			
	Communication	TCP/IP, Modbus TCP, Modbus RTU, Profinet, Ethernet/IP		TCP/IP, Modbus TCP, Modbus RTU, Profinet, Ethernet/IP		TCP/IP, Modbus TCP, Modbus RTU, Profinet, Ethernet/IP			
	Power	100-240 VAC, 50-60 Hz		100-240 VAC, 50-60 Hz		100-240 VAC, 50-60 Hz			
	Size	410×307×235 mm (W×H×D)		410×307×235 mm (W×H×D)		410×307×235 mm (W×H×D)			
	Weight	15.4 kg		18 kg		18 kg			

# JAKA MiniCobo

## Product description

The JAKA MiniCobo is a lightweight and compact robot, easy to set up in many different work environments. It offers strong performance and flexibility with simple tools for customization.

With its small size, quiet operation, and sleek look, the JAKA MiniCobo is perfect for industries like education, retail, and services. Its cost-effective design makes it an ideal entry point for businesses looking to start their automation journey.







**Ideal for B2C**



**Cost-Effective**



**Lightweight**



**Weight**  
**<10 kg**



**Payload**  
**1-2 kg**



**Reach**  
**580 mm**



**Accuracy**  
**±0.1 mm**

## Application scenarios



Product features	Product parameters	JAKA Mini 1	JAKA Mini 2	
	Maximum payload		1 kg	2 kg
Weight (including cables)		9.4 kg	9.9 kg	
Reach		580 mm	580 mm	
Accuracy		±0.1 mm	±0.1 mm	
Number of axis		6		
Programming		Drag teaching and graphic programming		
Teach pendant		Mobile terminal (computer/pad/mobile phone)		
Collaborative operation		Collaborative operation as ISO 10218-1: 2011		
Movement	Robot joint	Working range		
	Joint 1	±360°		
	Joint 2	±125°		
	Joint 3	±130°		
	Joint 4	±360°		
	Joint 5	±120°		
	Joint 6	±360°		
	Typical TCP speed	1 m/s		
Specifications	Nominal power consumption	150 W	180 W	
	Rated voltage	24 VDC	48 VDC	
	Operational temperature	0-50°C	0-50°C	
	IP classification	IP40	IP40	
	Robot mounting angle	Any orientation		
	Tool I/O interface	2 Digital inputs		
		2 Digital outputs		
		2 Analog inputs		
	Tool I/O power	24 VDC		
	Tool I/O size	M8		
	Materials	Aluminum, PC		
	Base diameter	124 mm		
	Cable length	6 m		
	Electrical cabinet	Power input	20-60 VDC	
		I-Out	≤40 A	
Size		180×128×47 mm (L×W×H)		
IP level		IP20		
I/O		7 Digital input: I/O configurable		
I/O Power		24 VDC		
Installation		Panel/Guide Rail		
Communication		TCP/IP, Modbus TCP, Modbus RTU, Profinet, Ethernet/IP		
Weight		1.1 kg		
Material		Aluminum, Steel		

**JAKA Lens 2D**

- Flexible and Convenient**  
Vision system for easy adaptation to different scenarios.
- Customizable**  
Drag-and-drop programming with flexible function combinations for tailored inspections.
- Easy Integration**  
Seamless software and hardware integration for quick and easy deployment.

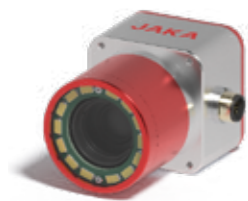

**Product description**

The JAKA Lens 2D is a high-resolution camera with adjustable lighting designed for clear 2D image capture. It allows real-time imaging with the flexibility to control the light source.

With features like automatic target recognition, visual positioning, and easy calibration, the system is simple to set up and operate for various image processing needs.

Lens 2D parameter	Lens 2D CGC500-F08	Lens 2D CGC500-F16
Resolution	2592×1944	2592×1944
Max frame rate	24 fps	24 fps
Data interface	GigE	GigE
Color mode	Black and white / color	Black and white / color
Lens focal length	8 mm	16 mm

**JAKA Lens VPS**

- High Reliability**  
Effectively isolates external factors. Provides stable and consistent protection.
- High Performance**  
Combines high-speed with large storage capacity. Features an embedded acceleration engine for enhanced performance.
- High Convenience**  
No complex software installation required. Easily accessible through a standard web browser.



**Product description**

The JAKA virtual protection system uses an industrial wide-angle camera and a vision system from JAKA and is directly connected to the cobot controller. The camera is placed above the robot's working area to monitor the working scene. If an external object (a person or a device) enters the monitoring area, the camera system detects the interference and sends instructions to the robot to take appropriate safety measures to ensure the safety of man and machine.

Lens VPS parameter	JAKA Lens Virtual Protection System
Resolution	820 w Pixel
Response time	200 ms
Installation height	2.5 m (suggested) GigE
Scope of protection area	5 m × 2,6 m (adjustable)
Installation mode	Directly above, side (any angle)

**JAKA StandardCab**

- Seamless Integration**  
Meets the operational needs of full-load models.
- Adaptable**  
Equipped with extensive I/O's and industrial communication interfaces.
- Smart Connectivity**  
Integrated industrial multi-protocol control module.



**Product description**

The JAKA StandardCab is a durable robot controller designed for seamless operation and communication with JAKA collaborative robots. It features an integrated wireless network module for mobile deployment and connectivity. Compatible with all JAKA cobots, it supports multiple device interfaces and industrial protocols, enabling integration with various equipment, including 3D vision systems, photoelectric sensors, conveyor belts, and laser scanners—offering a flexible and versatile automation solution.

Parameters	JAKA StandardCab
IP rating	IP44
IO Interfaces	16 digital inputs, 16 digital outputs, 2 analog inputs or outputs
Power supply (internal)	24 V
Communication	TCP/IP, Modbus TCP, Modbus RTU, Profinet, Ethernet/IP
Power supply	100-240 V AC, 50-60 Hz
Cabinet size	410×307×235 mm (W×H×D)
Weight	13 kg
Material	Plastic sprayed carbon steel plate

**JAKA MiniCab**

- Space-Saving Design**  
Compact mini control cabinet for efficient use of space.
- Wide Compatibility**  
Compatible with majority of JAKA collaborative robots.
- Portable**  
Designed for easy transport and mobile use.



**Product description**

The industry's smallest robot controller, weighing only 1.1 kg, supports a wide DC input power range, is compatible with various models and power loads, features an integrated wireless network module, and is ideal for mobile platforms like AGVs or industrial electrical cabinets.

Parameters	JAKA MiniCab
Input power / current	DC30-60 V / ≤40 A
Controller size	180×28×47 mm (L×W×H)
IP rating	IP20
IO Ports	7-way port; Input and output configurable
Power supply (internal)	DC 24 V
Installation method	Panel / guide rail
Communication	TCP/IP, Modbus TCP, Modbus RTU, Profinet, Ethernet/IP
Weight	About 1.7 kg (including accessories)
Material	Aluminum alloy, steel

## Flexible Programming of JAKA Robots

Whether you're a seasoned robotics engineer or new to automation, JAKA makes programming effortless and efficient. With numerous versatile programming options – ranging from intuitive drag-and-drop interfaces to advanced coding flexibility – we cater to diverse industries, applications, and skill levels. No matter your expertise, JAKA ensures a seamless programming experience, allowing you to focus on optimizing productivity.



### JAKA Zu® App

The JAKA Zu App is our user-friendly programming platform based on the widely used programming language Scratch. Designed for simplicity, it allows users to program JAKA robots through an intuitive drag-and-drop interface on tablets or smartphones.



- **Ideal For:** Beginners and operators with minimal programming experience.
- **Key Features:** Visual programming, real-time control, large variety of drag-and-drop commands.



### Drag & Teach

With JAKA's direct teaching feature, users can simply guide the robot arm through desired movements to program tasks. This intuitive method reduces the learning curve and accelerates setup time.

- **Ideal For:** Quick setups and repetitive tasks.
- **Key Features:** Easy task recording, no prior programming knowledge required.



### SRCI (Standard Robot Communication Interface)

SRCI enables seamless integration of JAKA robots into PLC automation using standard Profinet protocols. It is designed for industries that require robust and reliable connectivity.

- **Ideal For:** Technicians with prior experience on SIMATIC hardware and software.
- **Key Features:** The use of SIMATIC Robot Integrator via TIA Portal.

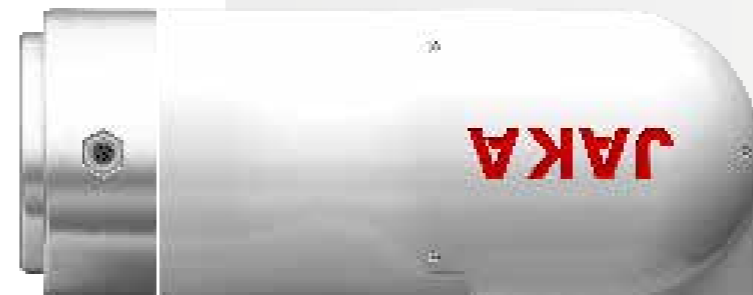

### TCP-IP

JAKA supports an external control protocol based on TCP/IP, offering a comprehensive set of interfaces that enable customers to control the robot and retrieve information.

- **Ideal For:** Programming environments with TCP server structure.
- **Key Features:** TCP server on the robot controller to receive specific commands and provide feedback status data.



### JAKA SDK (Software Development Kit)

JAKA SDK is a comprehensive toolkit designed for developers and skilled system integrators to efficiently build applications for collaborative robots.

- **Ideal For:** Advanced users, software developers, and integrators.
- **Key Features:** The SDK communicates with the robot over TCP/IP and is available as a library for C/C++, C#, and Python.



### Offline Programming

The JAKA Virtual Machine, along with third-party software like RoboDK, offers an efficient solution for programming without a physical robot: create, simulate, and test programs in a virtual environment before deployment.

- **Ideal For:** Environments where downtime must be minimized, or where a physical connection to the robot is unavailable, such as training and education settings.
- **Key Features:** Connect the JAKA Zu® App to the virtual machine using an IP address. The virtual machine can also be operated through TCP/IP and the JAKA SDK, with these functions also available via third-party software.

# JAKA

## Key Industries



- Automotive
- Electronics
- Semiconductor
- Manufacturing
- Medical
- Food & Beverage
- Chemical
- Renewable Energy
- Education
- Agriculture

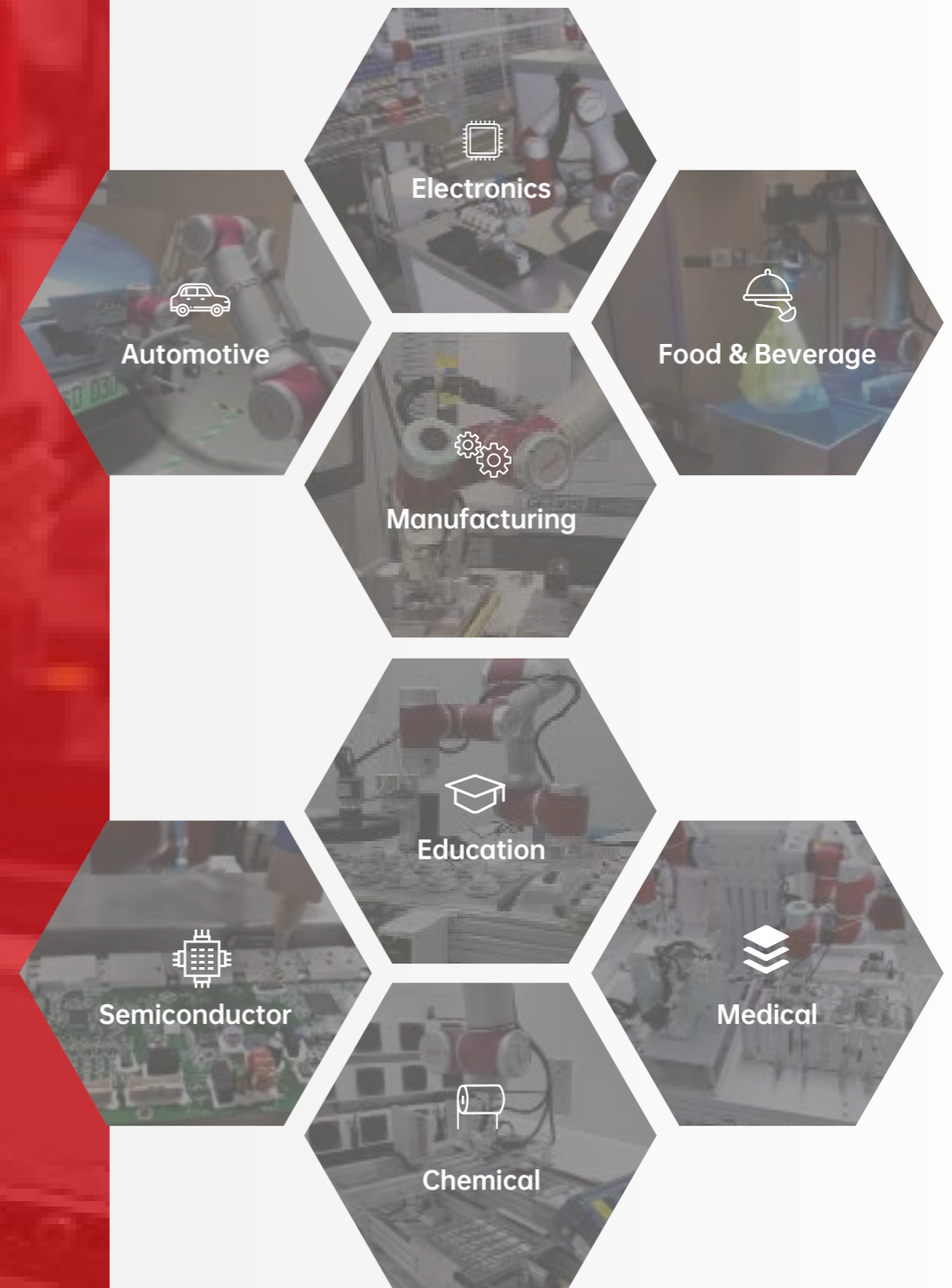

Automotive Industry

Dust removal from lighting covers



Screwing in lighting assemblies



BEV automatic charging station



Lighting strip quality control



Screwing in powertrain assemblies



Electric drivetrain wire winding



Automotive blind riveting



Belt tension inspection



Battery pack spraying operations



Transmission housing handling



Screwing in seat assemblies



Machine tending for stamped parts



Mirror quality control inspection



Handling operations for shelves



Machine tending for exhaust systems



Machine tending operations for suspension parts



**Electronics / Semiconductor Industry**



CNC Machine tending with AGV/Robot



Power module coating



Scanning and inspection of battery packs



Soldering



Quality inspection of PCB boards



Visual inspection on smartphones



Buzzer detection



Handling operations during product assembly



Glue residue removal in earbuds



Quality inspection for smartwatches



Quality inspection for semiconductor parts



Gluing operations on PCB boards



Laser etching for electronics



Screwing operations on lamp assembly



Assembly with dual arms



Blanking operations on PCBs



Sandblast cleaning operations



Protective film removal



Gluing operations on PCs



Handling operation on PCB boards

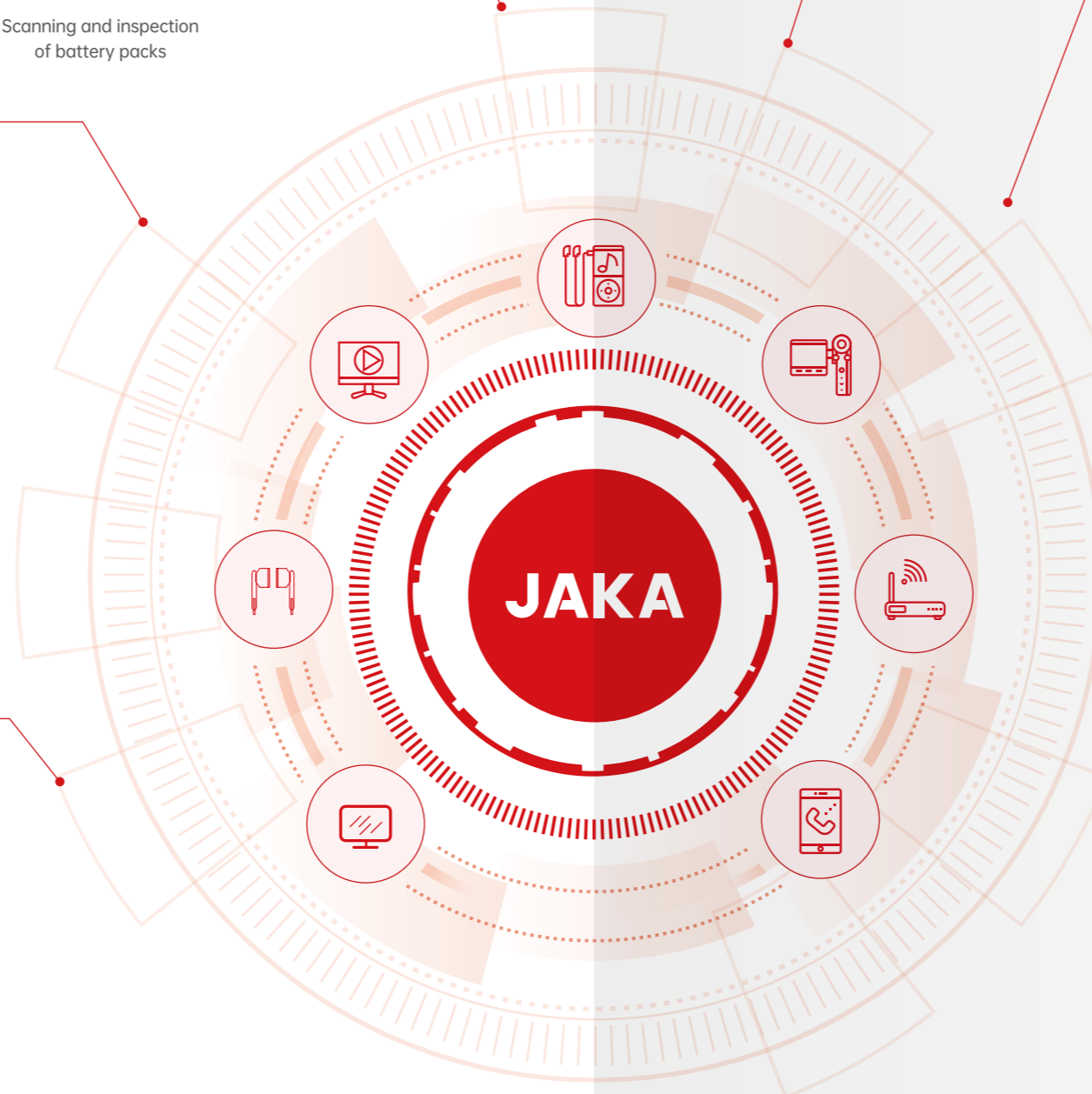

Other Industrial and Commercial Sectors

Manufacturing



Food & Beverage



Renewable Energy



Medical



Electrical Appliances



Hospitality



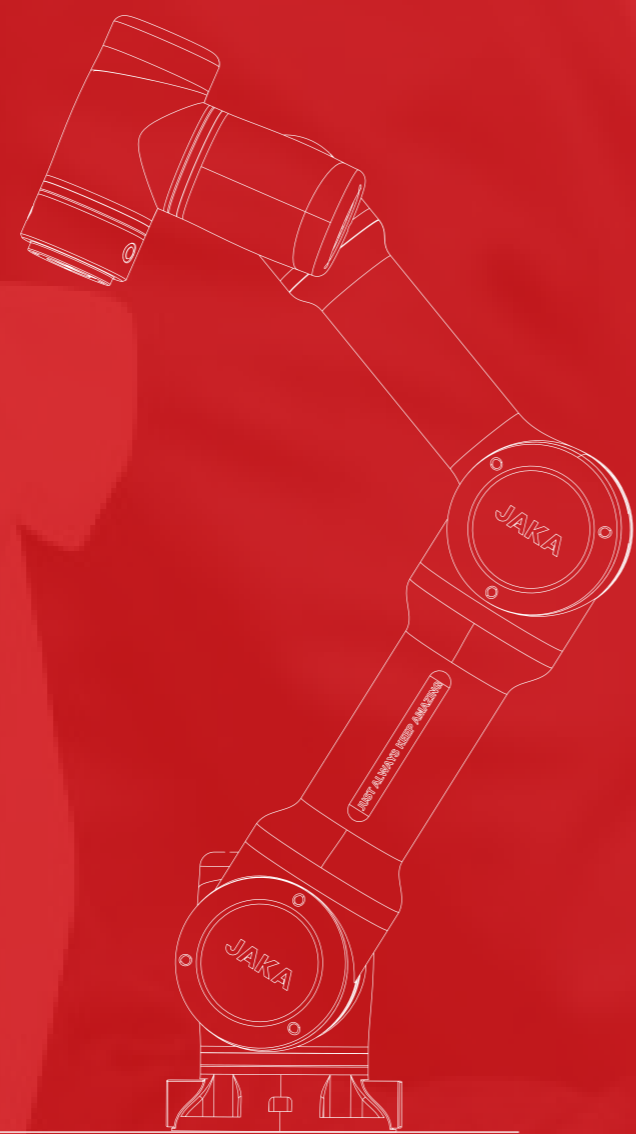

# JAKA

## Customer focused service approach



24/7 online support



Professional technical support



Digital solutions



Full service tracking



High-level training in the industry

# jaka.com

## Publisher

---

 JAKA Robotics GmbH: Siemensstr. 31 / Breslauer Str. 10, 90766 Fuerth, Germany

 [marketing.eu@jaka.com](mailto:marketing.eu@jaka.com)

---

Copyright © 2025 JAKA. All rights reserved.

### Disclaimers:

The copyright belongs to JAKA and cannot be copied or reproduced in any form without written permission. The company reserves the right to interpret and update the contents of the materials without notice.

---